

INSTALLATION GUIDE

You Will Need

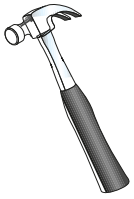

Hammer

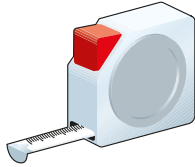

Tape Measure



Shears

Be Safe

1. Always assess the job before any work at height is carried out.
2. Ensure all equipment is checked, is suitable and in good repair.
3. Ensure adequate fall restraints and protective gear are used
4. Always wear safety clothes on-site.

1. Check the Tiles are Genuine

Look on the back of the tile for the production code.

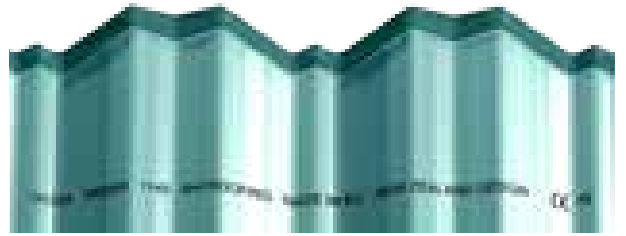

Please call: 0810 300 2000 to check.

MAKE SURE IT'S
#GenuineGerard

2. Battens

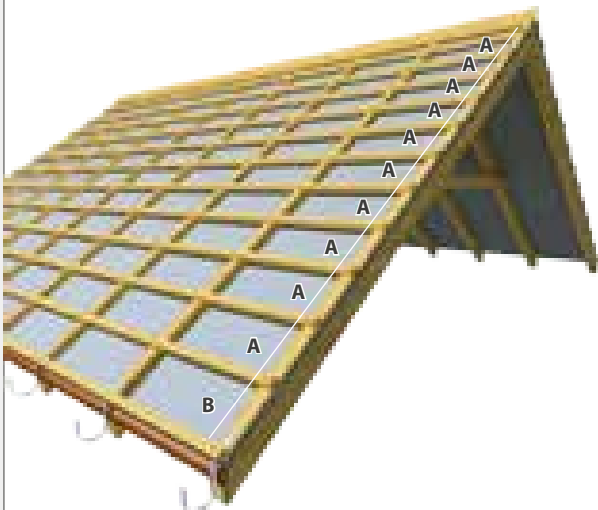

Batten Space

A	B
369mm	329mm

3. Lay the Tiles

Tiles should be laid from the ridge down in the order shown.

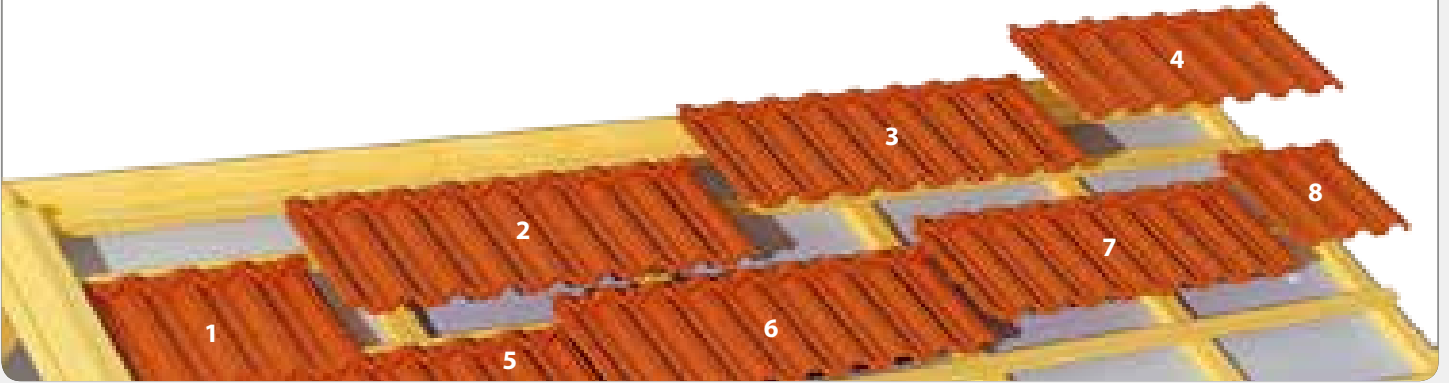

4. Secure the Tiles

Fix 4 nails per tile ensuring the overlapping tiles are nailed together.

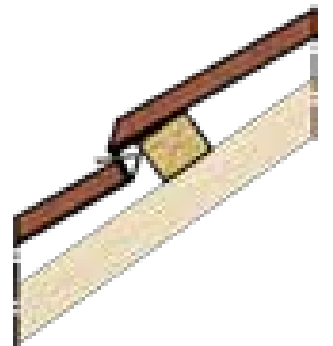
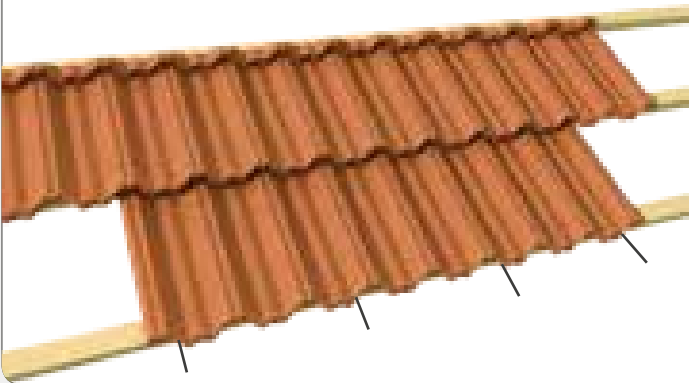

5. Ridge Tile

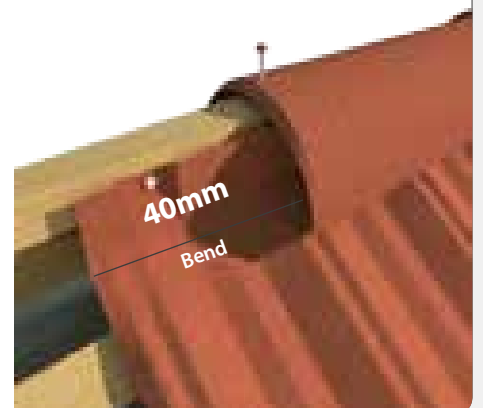
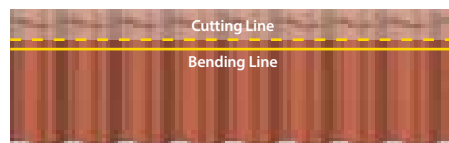
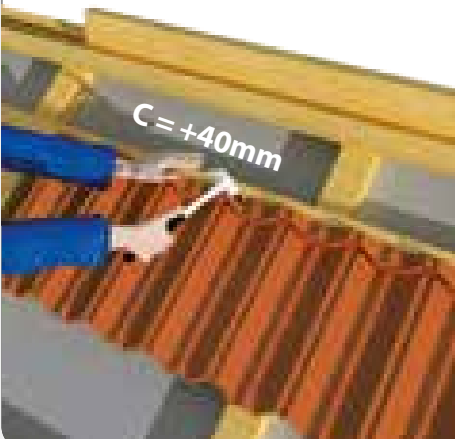



6. Ridge Cap

Tiles should be laid from the ridge down in the order shown.

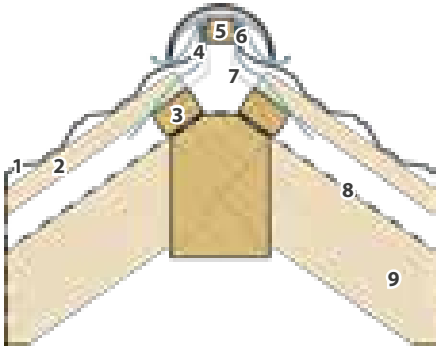

1. Tile
2. Tile Batten
3. Ventilation Space Batten
4. Ridge
5. Hip Batten
6. Air Outlet
7. Hip Bracket
8. Decra Foil
9. Rafter

7. Box Barge

Fix 4 nails per tile ensuring the overlapping tiles are nailed together.

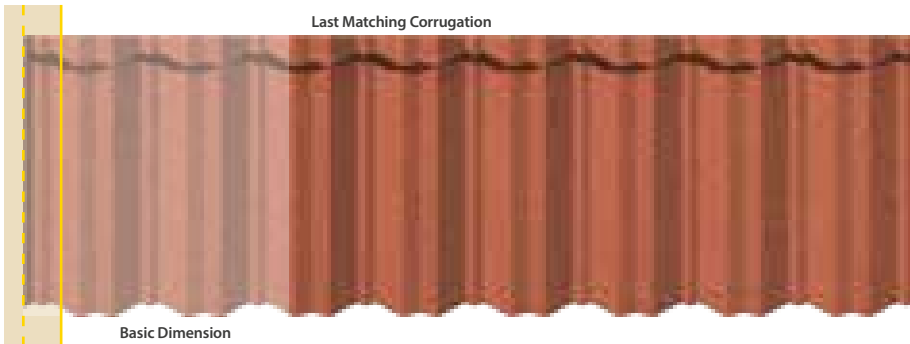

8. Valley

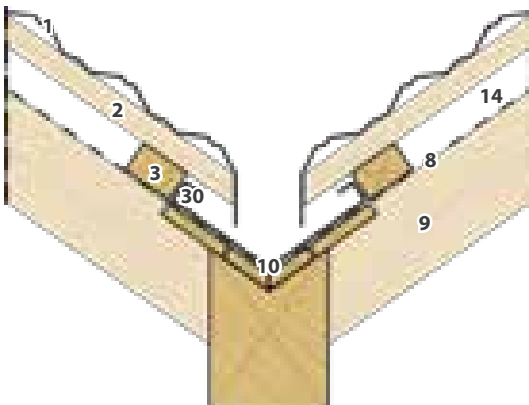

1. Tile
2. Tile Batten
3. Ventilation Space Batten
8. Decra Foil
9. Rafter
10. Valley
14. Ventilation Space
30. Clip

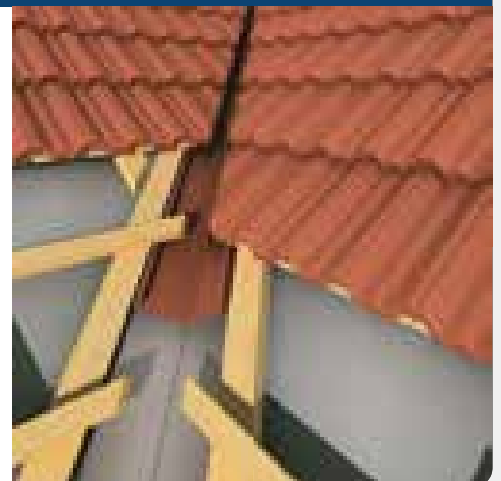

9. Wall Flashing

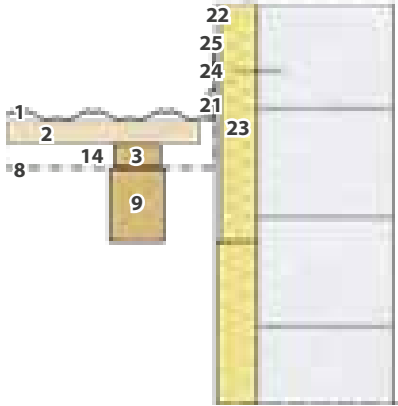

- 1. Tile
- 2. Batten
- 3. Ventilation Space Batten
- 8. Decra Foil
- 9. Rafter
- 14. Ventilation Space
- 21. Side Flashing
- 22. Render
- 23. Warmth Insulation
- 24. Purpose-made Side Flashing
- 25. Sealant



10. Cutting and Bending the Tile

1. Measure and mark the required measurements taken from the roof on the tiles with chalk or similar, ensuring that the matching corrugation of the overlapping tile to be cut is taken as the measurement starting point. This forms the bending line.
2. Flatten both upstands of the tile where it is to be cut. This will make cutting easier.
3. Cut the tile along the marked cutting line using the guillotine, hand shears or a metal cutting saw.
4. Bend the tile using a short tile bender.



Help Line

0810 300 2000

